

modello

INTEGRA

PLANA



# Integra Plana

Fascino moderno dallo stile complanare

## Finestra in legno complanare.

---

Integra Plana è il serramento perfetto per chi ama il design pulito ed essenziale. Il nome ha origine dalla sua principale caratteristica: il vetro è parte integrante della finestra, pertanto è privo di listello fermavetro.

La bellezza estetica viene esaltata dalle ante complanari, dotate di funzionali cerniere a scomparsa e dal telaio inferiore della finestra realizzato interamente in legno. Il serramento non presenta sporgenze: profili ed elementi sono allineati per adattarsi perfettamente al contesto architettonico in cui è integrato.

La sapiente scelta dei legni più pregiati rendono Integra Plana una soluzione esclusiva per valorizzare gli ambienti dallo stile più moderno.



Cod. 3129 Rovere

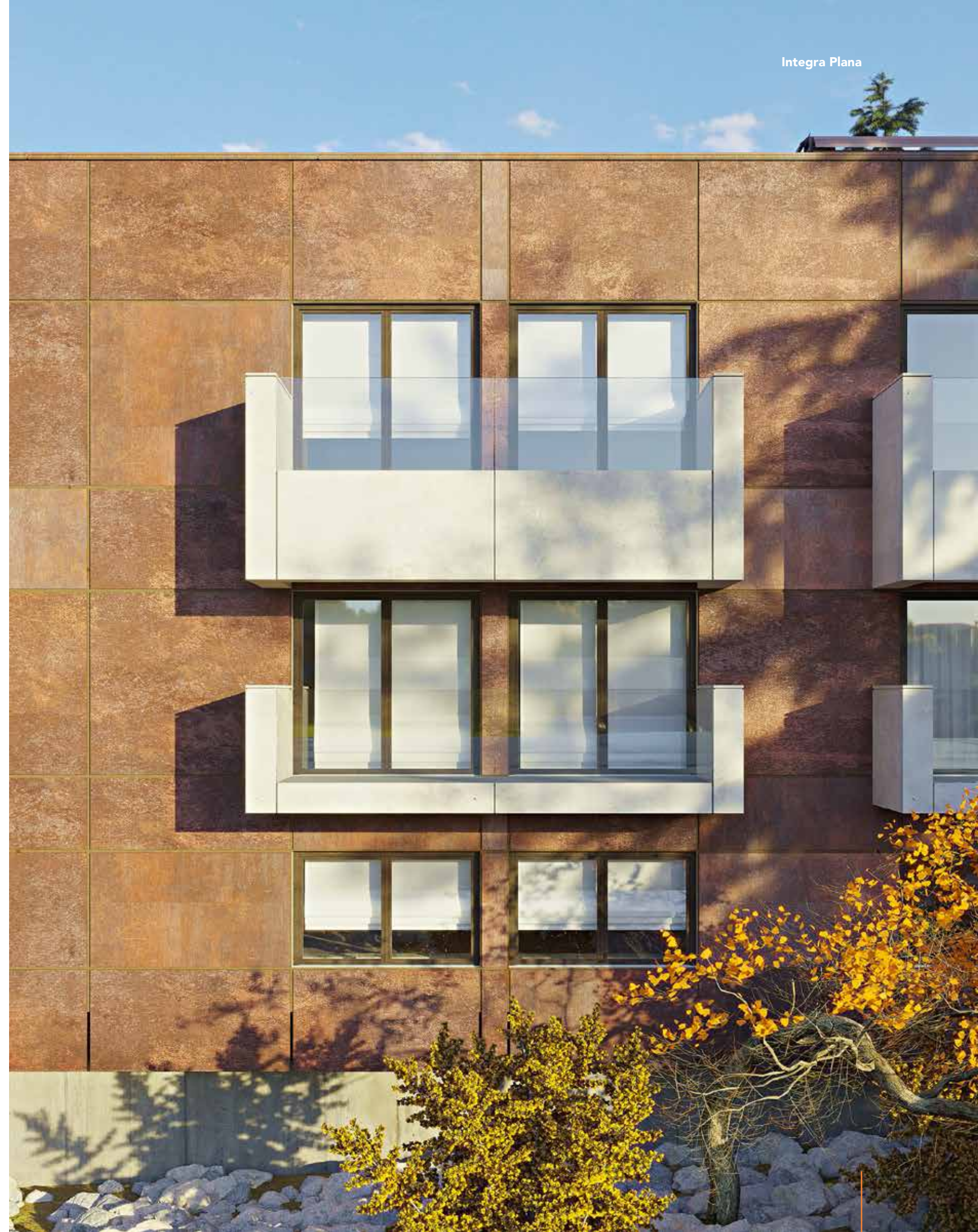





Vista esterna del complesso



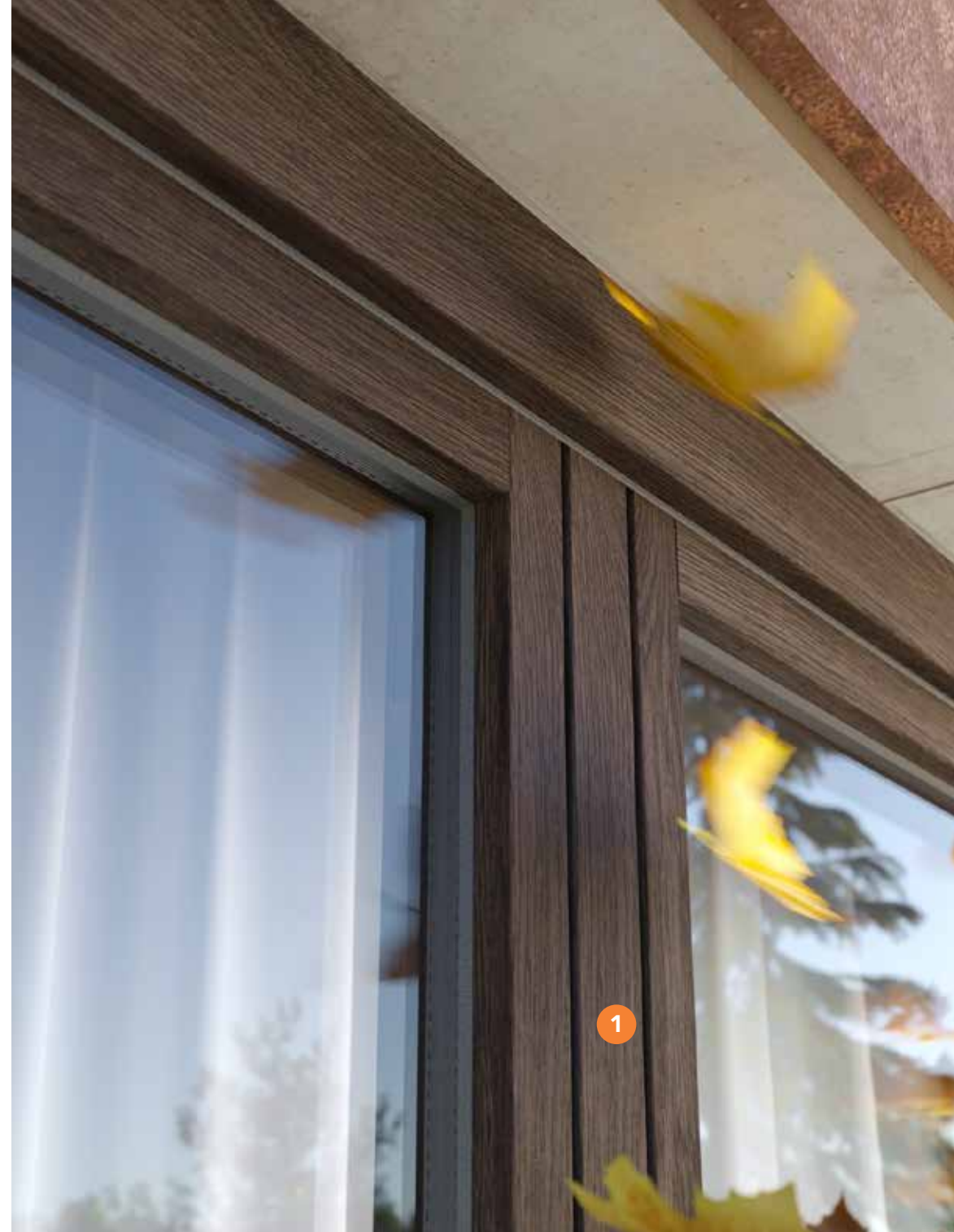

**Integra Plana - finestra in legno complanare stile Pura / Plana**

1 - Particolare nodo centrale esterno complanare



Moderno



Integra Plana



- 1 - Particolare anta con cerniere a scomparsa
- 2 - Particolare interno nodo centrale complanare asimmetrico



# Integra Plana

Portafinestra in legno complanare.

Vista interna



Stile Pura / Plana

Integra Plana

Portafinestra in legno complanare.

Vista esterna



Stile Pura / Plana

# Integra Plana

Finestra in legno complanare.

Vista interna



Stile Pura / Plana

Integra Plana

Finestra in legno complanare.

Vista esterna

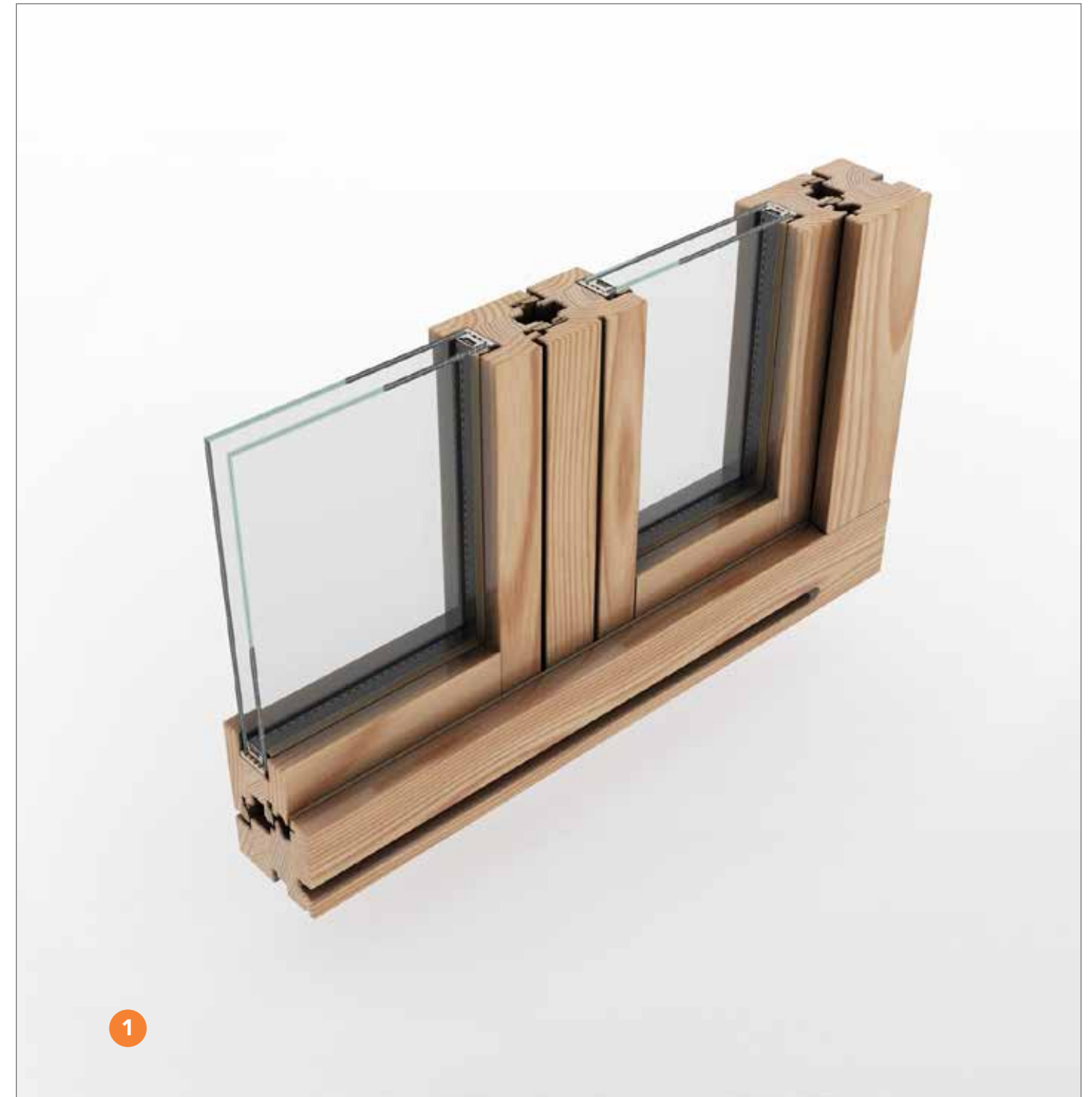

Stile Pura / Plana

# Integra Plana

Finestra in legno

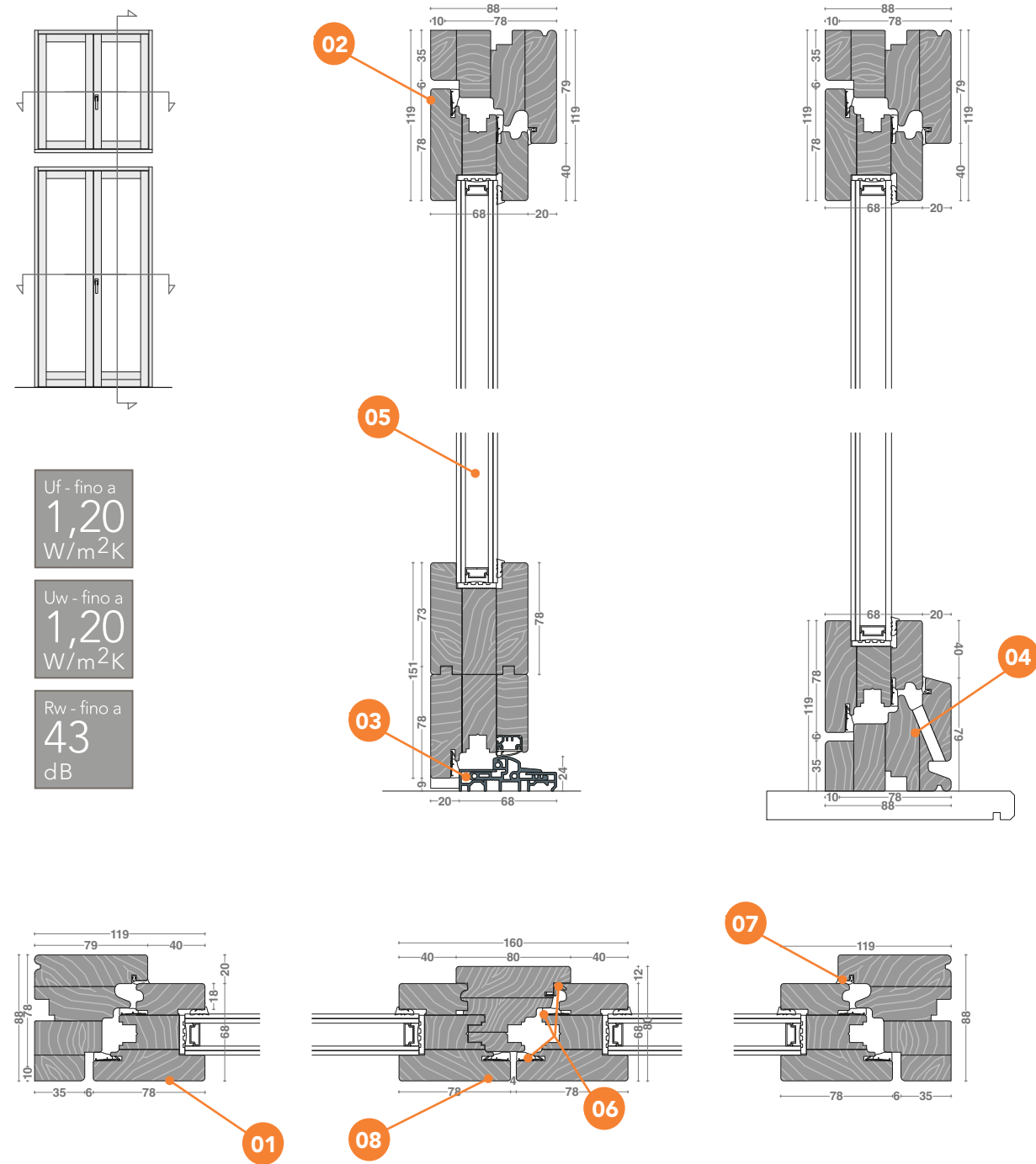

01 "Stile Pura" ( profilo dritto ) 02 "Plana" ( anta e telaio complanari ) 03 Soglia a taglio termico 04 Gocciolatoio in legno 05 Vetrocamera 06 Guarnizioni in polipropilene e schiuma uretanica 07 Guarnizioni in EPDM 08 Nodo centrale simmetrico complanare

# Integra Plana

Stili disponibili: Pura e Prisma

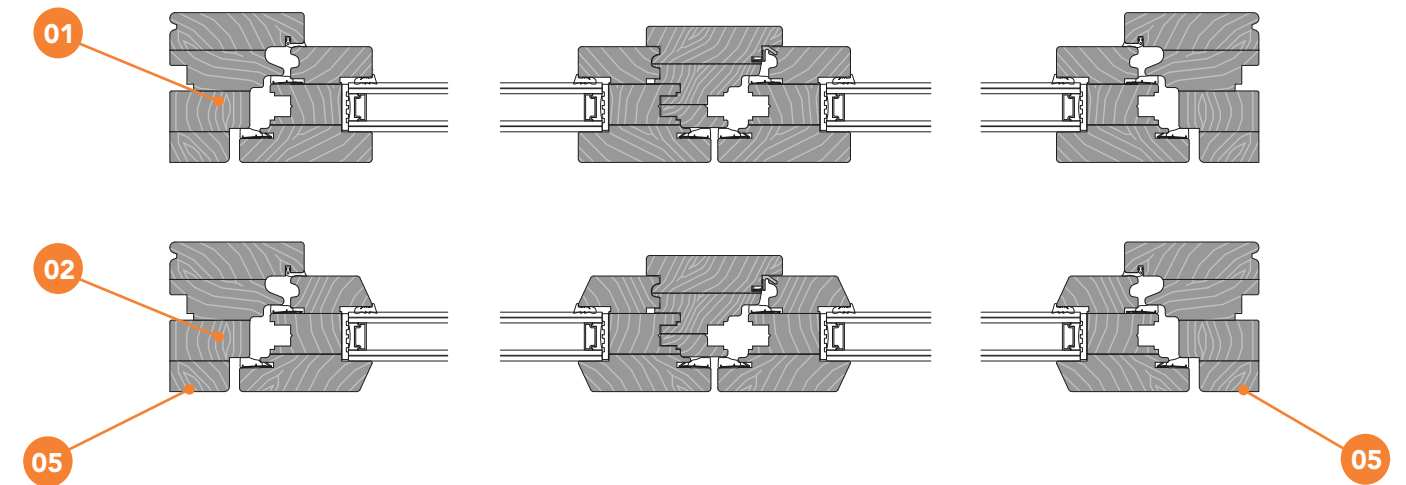

## Allestimenti Optional

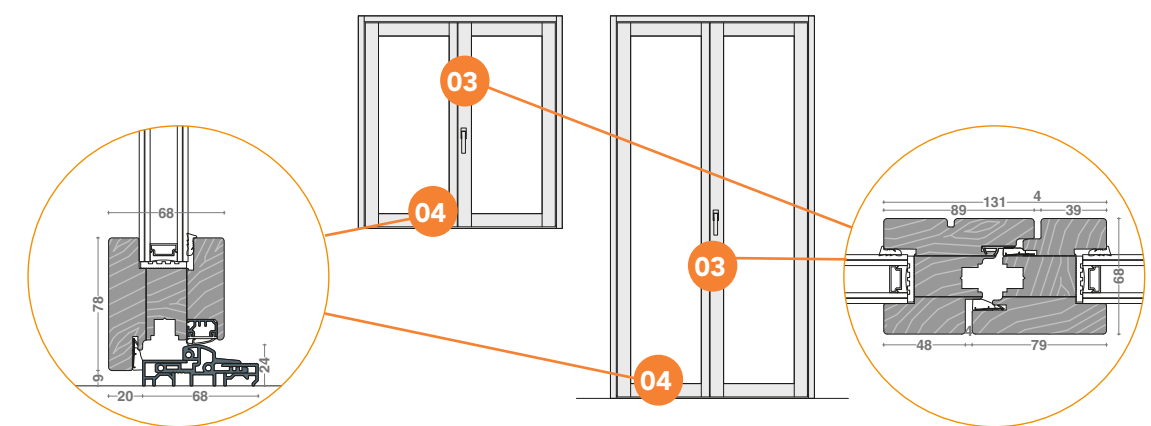

01 Stile Pura 02 Stile Prisma 03 Variante nodo centrale asimmetrico disponibile per finestra e portafinestra 04 Variante gocciolatoio in alluminio portafinestra disponibile anche per solo finestra 05 Variante scasso telaio per coprifilo a filo anta



## Finiture Legno RAL

Laccati

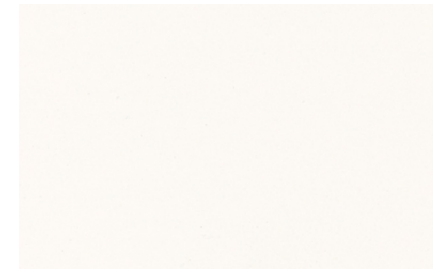

RAL 9010  
Abete - Okumè

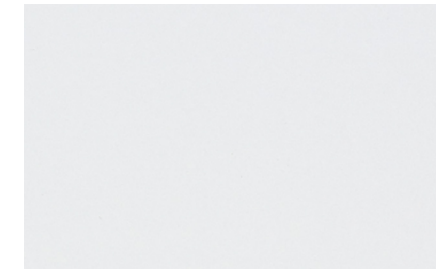

RAL 7035  
Abete - Pino - Okumè

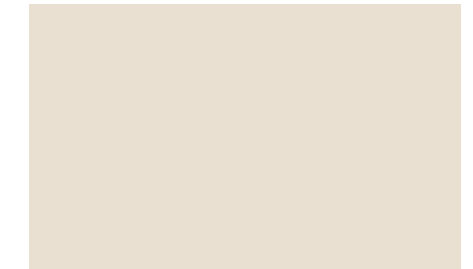

RAL 9001  
Abete - Pino - Okumè



RAL 1013  
Abete - Pino - Okumè

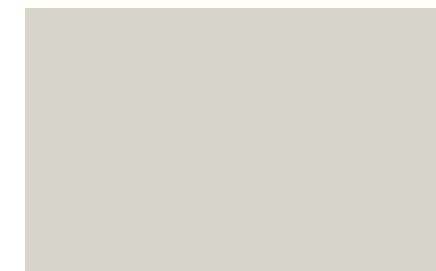

RAL 9002  
Abete - Pino - Okumè



RAL 7044  
Abete - Pino - Okumè

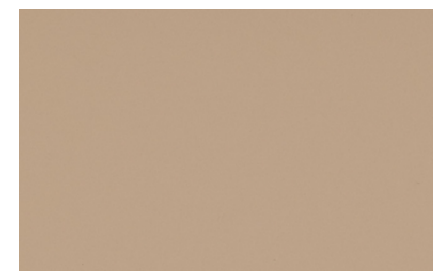

RAL 1019  
Abete - Pino - Okumè



RAL 9007 Metallizzato  
Abete

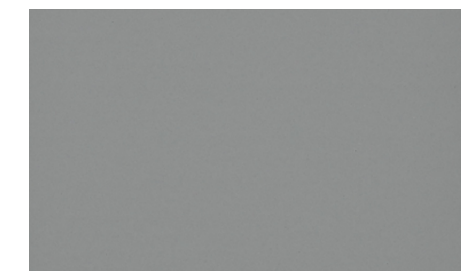

RAL 7037  
Abete - Pino - Okumè



RAL 6011  
Abete - Pino - Okumè



RAL 6012  
Abete - Pino - Okumè



RAL 7016  
Abete - Pino - Okumè

I colori delle finiture sono puramente indicativi

**Finiture**  
Legno, alluminio e RAL



## Finiture Legno

Essenze

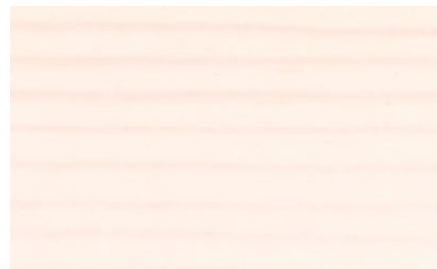

Cod. Sbiancato  
Abete

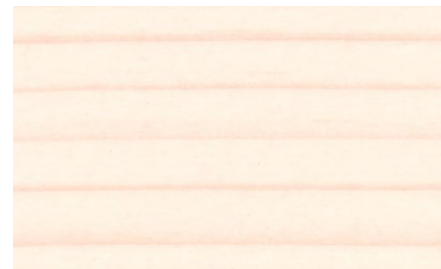

Cod. 0575  
Abete

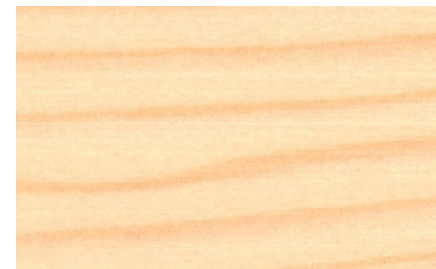

Cod. 0220  
Abete



Cod. 0281  
Abete - Pino



Cod. 1077  
Abete - Pino

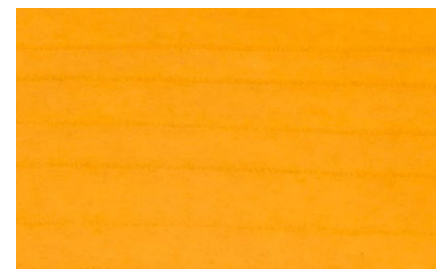

Cod. 1028  
Abete - Pino



Cod. 1328  
Abete - Pino

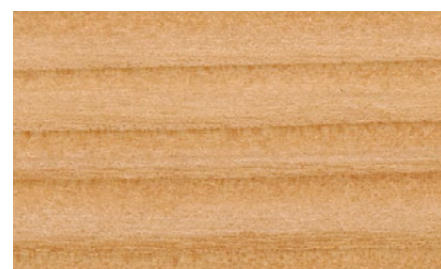

Cod. 0280  
Larice - Spazzolato



Cod. 9480  
Larice

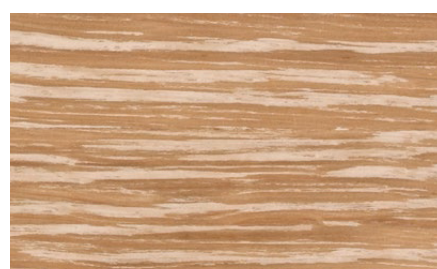

Cod. 0020  
Rovere Spazzolato



Cod. 0220  
Rovere - Castagno

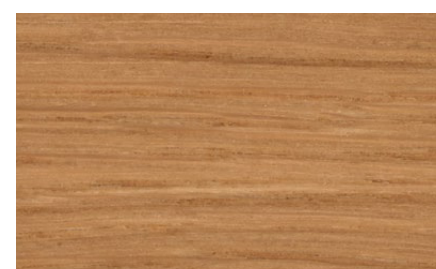

Cod. 0279  
Rovere - Castagno

I colori delle finiture sono puramente indicativi

## Finiture Legno

Essenze



Cod. 5720  
Rovere Spazzolato

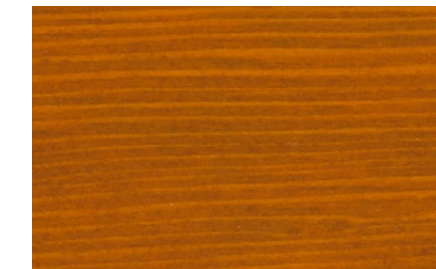

Cod. 1928  
Abete - Pino

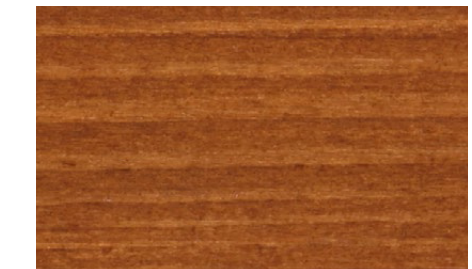

Cod. 5379  
Rovere

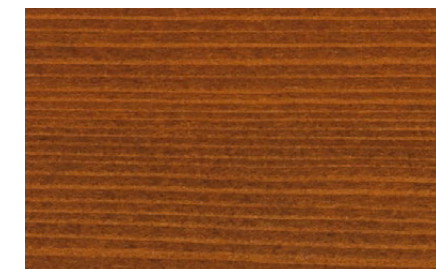

Cod. 2650  
Abete - Pino

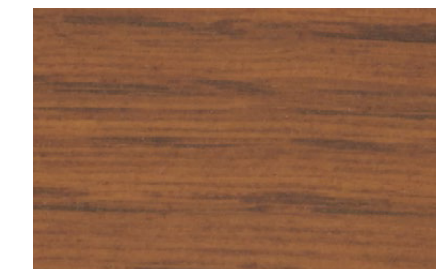

Cod. 5328  
Rovere - Castagno

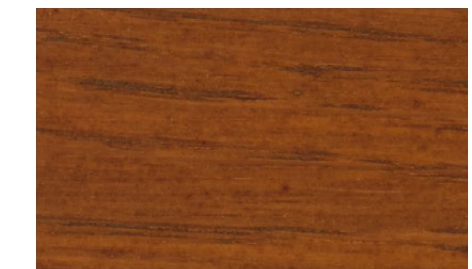

Cod. 5390  
Rovere - Castagno

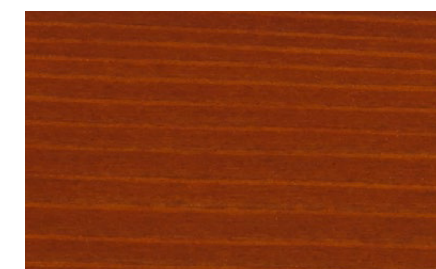

Cod. 2229  
Abete - Pino

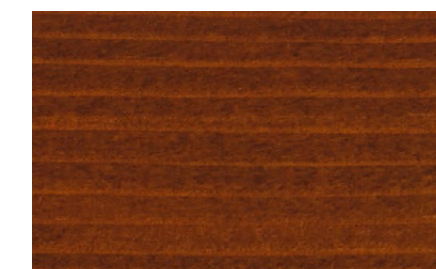

Cod. 2629  
Abete - Pino

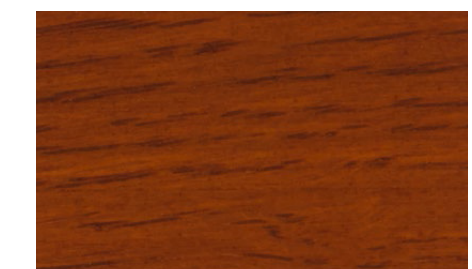

Cod. 5329  
Rovere - Castagno

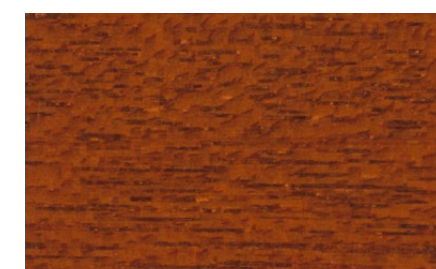

Cod. 5250  
Okumè

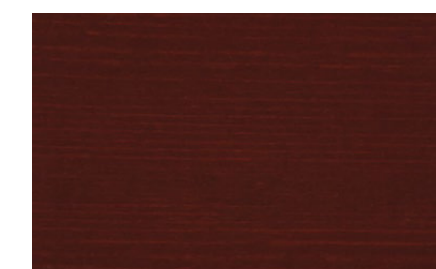

Cod. 2729  
Abete - Pino

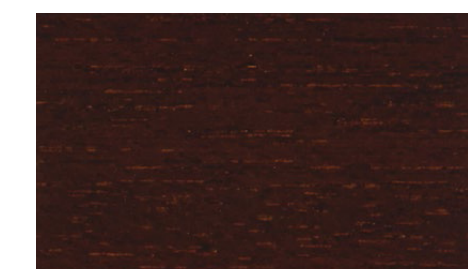

Cod. 5329  
Okumè - Rovere

I colori delle finiture sono puramente indicativi



## Finiture Alluminio

Decorati - Metallo - Inox -Bronzo -Brunnelleschi

### Decorato

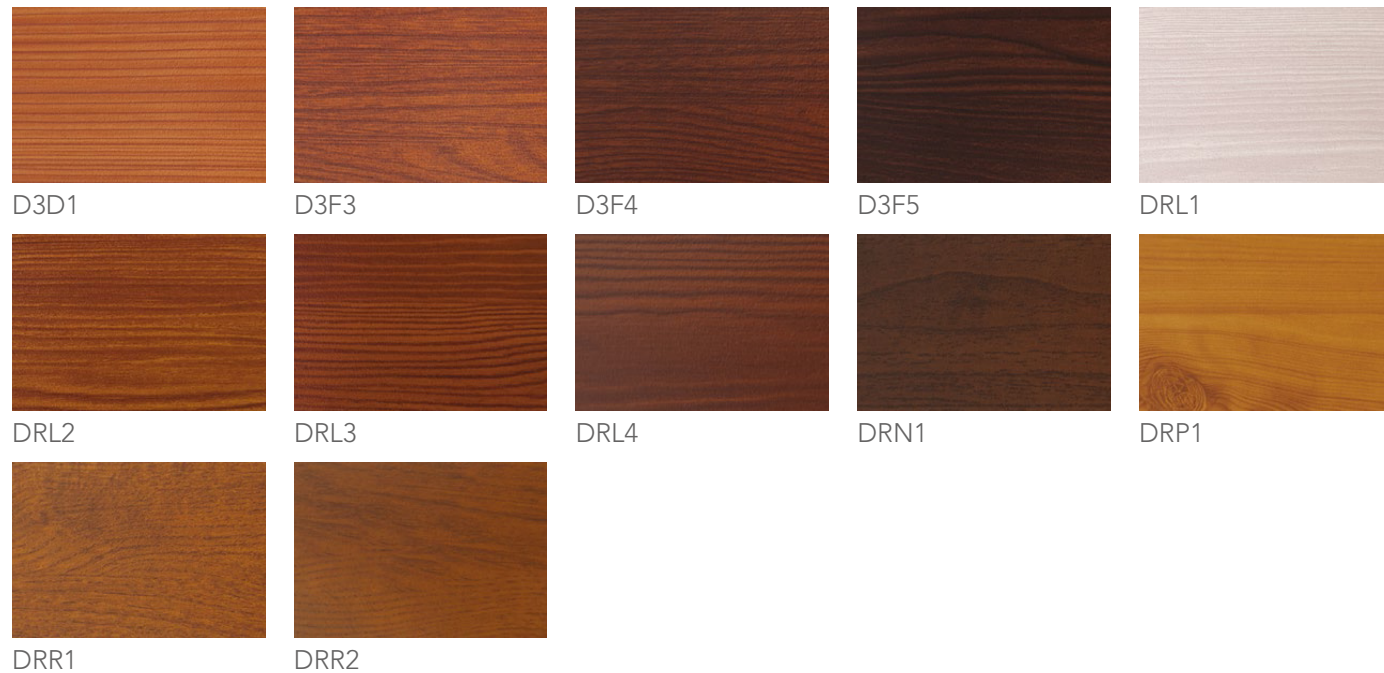

### Metallo

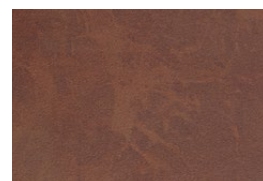

DMCT

### Inox



Ossidato

### Bronzo

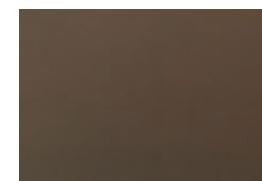

Brunito

### Bronzo

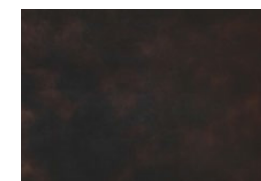

Antico

### Brunnelleschi

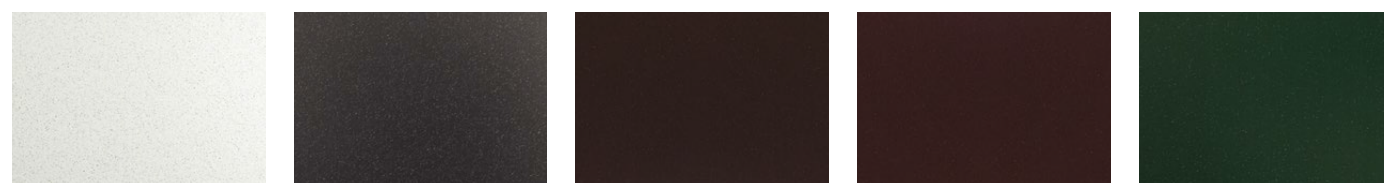

BR-B

BR-G

BR-M

BR-R

BR-V

I colori delle finiture sono puramente indicativi

## Finiture Alluminio

Ossidati - Oxipulver - Sablé - RAL

### Ossidati

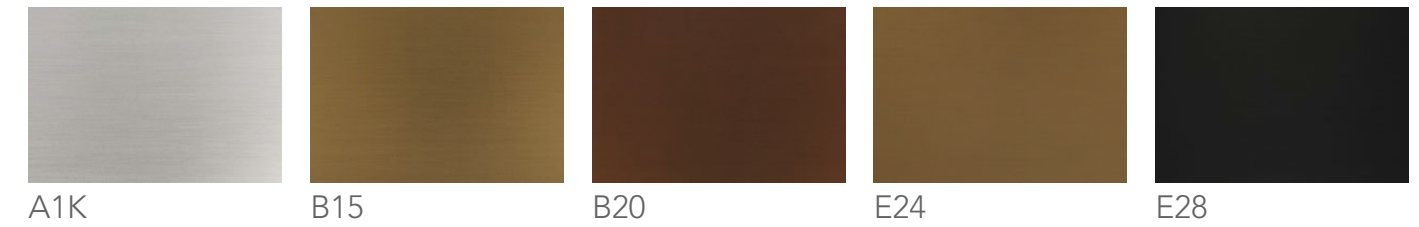

### Oxipulver

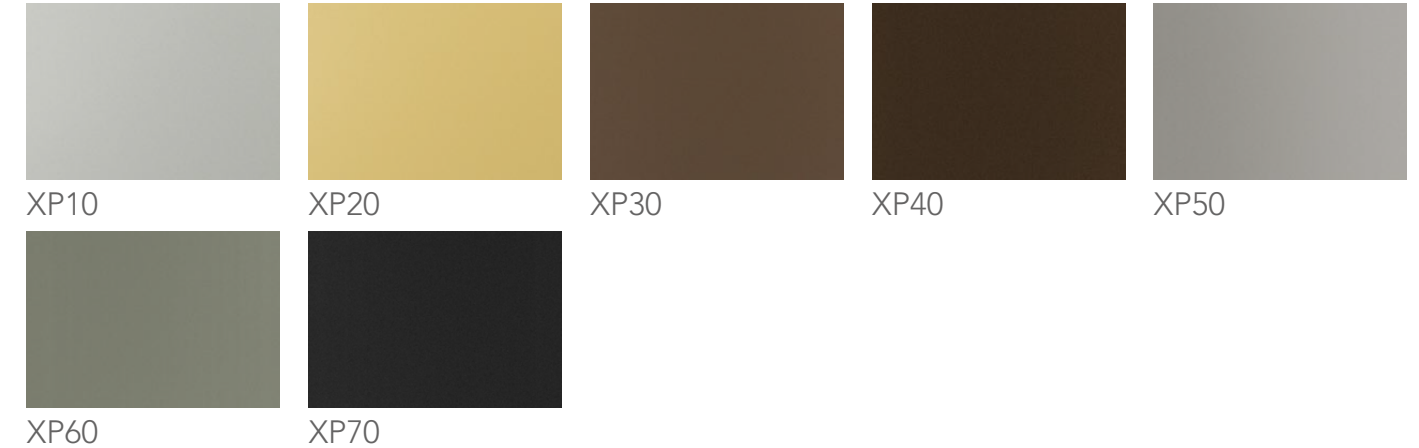

### Sablé



## Tabelle RAL

RAL Standard Lucidi e Semilucidi

RAL Opachi

RAL Strutturati



I colori delle finiture sono puramente indicativi



## Goditi la luce e il comfort tutto l'anno

Tecnologia anche nei vetri senza compromessi

Il vetro riveste un ruolo fondamentale nella costruzione di un serramento, rappresentando circa l'80% della composizione di una finestra. Per queste ragioni selezioniamo solamente vetri, altamente performanti, che rispondono alle moderne esigenze di efficientamento energetico degli edifici e contribuiscono ad aumentare il comfort abitativo. Sulle finestre installiamo di serie vetri selettivi o 4S (4 stagioni), completi di gas argon e canalina a bordo caldo, che apportano agli ambienti interni i seguenti benefici:

Minori dispersioni di calore in inverno e un maggiore risparmio sulle spese di riscaldamento

Maggiore filtro dei raggi solari UV in estate e diminuzione delle spese di raffrescamento per l'uso dei condizionatori

Maggiore luminosità e comfort visivo

Utilizziamo solo vetri certificati e con una garanzia minima di 10 anni. A richiesta possiamo soddisfare qualsiasi esigenza ambientale per ottenere la massima prestazione termoacustica.

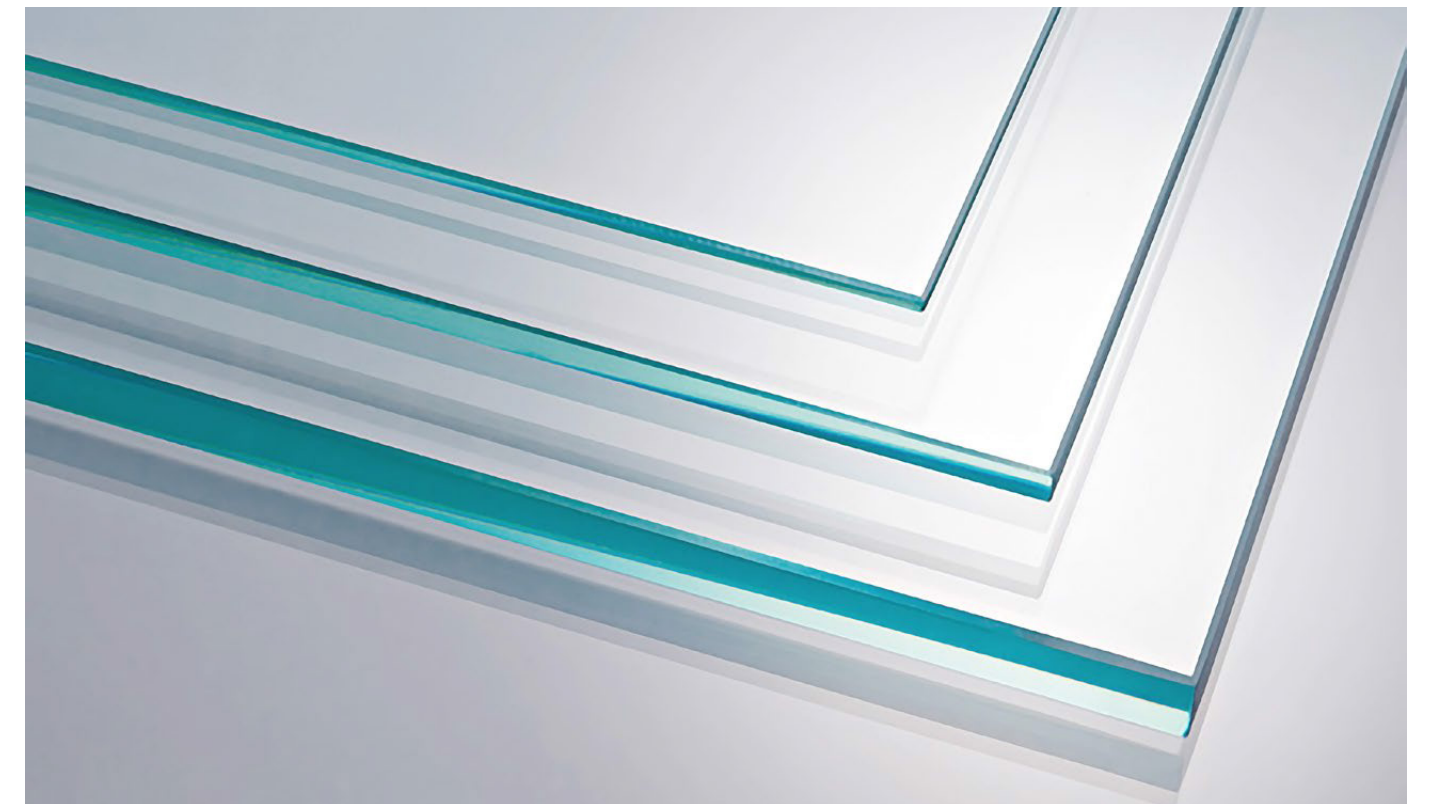

**Vetro**  
Benefici e caratteristiche  
tecniche



# Maniglie e Maniglioni finestre e scorrevoli

## Maniglie Toulon

Colori e versioni disponibili



Bianco



Argento



Bronzo



Oro



Nero



Bianco  
con pulsante



Argento  
con pulsante



Bronzo  
con pulsante



Oro  
con pulsante



Nero  
con pulsante



Bianco  
con chiave



Argento  
con chiave



Bronzo  
con chiave



Oro  
con chiave



Nero  
con chiave



# Maniglione Toulon per scorrevole

Colori e versioni disponibili

---



Argento



Bronzo



Oro



Nero

---



Oltre è un marchio della Dear S.r.l. Unipersonale

Via Lago dei Tartari, 3

00012 Guidonia Montecelio

RM

Tel: 0774.354467 [www.finestreoltre.it](http://www.finestreoltre.it) e [www.finestrecasaclima.it](http://www.finestrecasaclima.it)

e-mail: [info@finestreoltre.it](mailto:info@finestreoltre.it)

Capitale Sociale euro 300.000,00 i.v.

Cod. Fisc. - Partita I.V.A.: 06330721009

Art Director a cura di arch. Gabriele Vacca,

Tutti i fotorendering, illustrazioni, spacati assonometrici, grafici 2D e 3d a cura di : [www.zeronove.net](http://www.zeronove.net)

Foto pag. 5 by Dear

Fotolito Arch. Gabriele Vacca

Impaginato Davide Di Domenico

Testi Dott. Alessandro Guaglione

Stampa Bieffe

Per motivi di stampa, la rappresentazione dei colori e delle superfici non è perfettamente fedele all'originale. I prodotti descritti ed illustrati in questo catalogo ed i dettagli di equipaggiamento sono in parte dotazioni speciali non di serie e soggette a sovrapprezzo, dipendenti dalle varianti di equipaggiamento. Le descrizioni e le illustrazioni, i dati relativi a fornitura, possono essere soggette a variazioni. Diritti di autore riservati. Riproduzione, anche parziale, solo previa autorizzazione.

FINESTRE  
OLTRE